

THE PROPERTY OF THE DRAWING IS ESTABLISHED BY LAW. IT IS FORBIDDEN TO PRODUCE OR SHOW IT TO THIRD PART. WITHOUT A WRITTEN AGREEMENT.

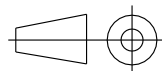
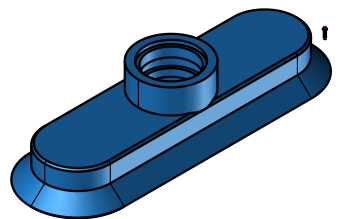
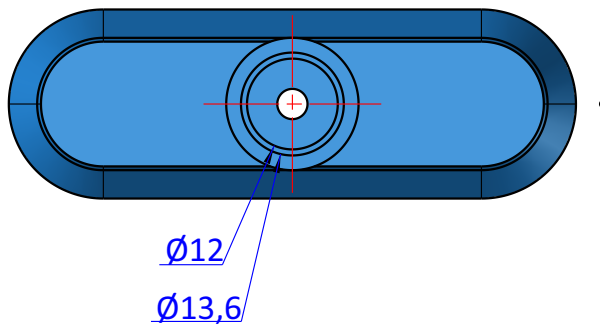
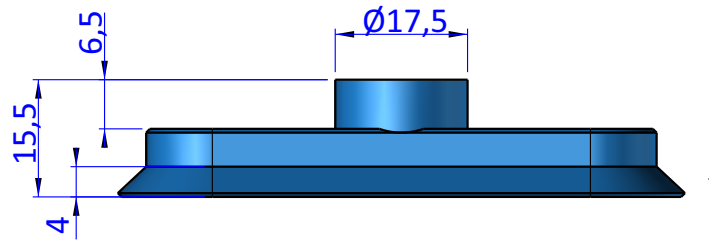
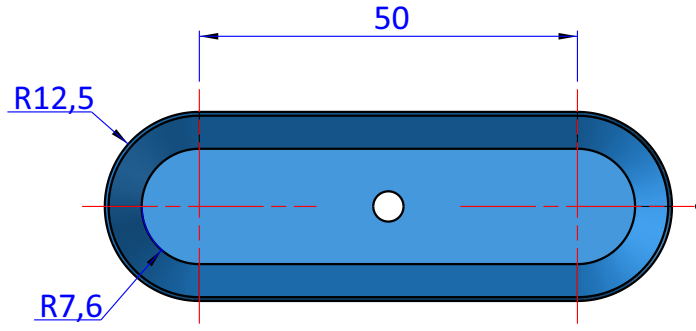

DESIGNED FROM
FPS Automation

REVIEW
A

DATE
06/10/2020

WEIGHT
0,018kg

CODE
CA.08.39.008

Format A4

UNI 936-76

GENERAL TOLERANCE
UNI - ISO 2768
CLASSE f

DESCRIPTION
CA.08.39.008